

Z2S10...type Modular Hydraulic Operated Check Valve



Z2S10...3XJ...type

Size 10
Max. Working Pressure: 315 bar
Max. Flow: 120 L/min

Contents

Function and configuration	02
Symbols	02
Specification	03
Technical data	03
Characteristic curves	03
Unit dimensions	04

Features

- Porting pattern to DIN 24 340
- Leakage-free closure for one or two ports
- Sandwich plate valve, for use in vertical stacking assemblies
- 4 cracking pressures, optional

Function and configuration

Z2S10 type valve is a releasable check valve in sandwich plate design. It is used for the leakage-free closure of one or two ports, also in case of long periods of time. Fluid flows freely from A1 to A2 or B1 to B2. Flow in the opposite direction is blocked. When fluid flows from A1 to A2, the spool (1) is pressurised and is pushed to the right, thereby opening the ball poppet valve (2) which then opens the check valve (3). In order to make the reliable closure of the two check valves in the neutral position, the service ports A1 and B1 must be connected to tank.

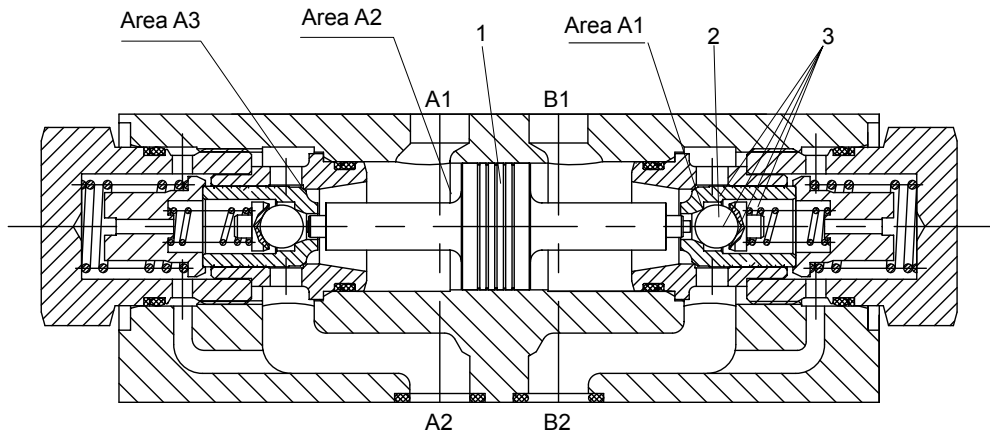

Z2S10..3XJ/...modular hydraulic check valve

1 Spool 2 Ball poppet valve 3 Check valve

Symbols (① =valve side, ② = sub-plate side)

Z2S10A..3XJ/...

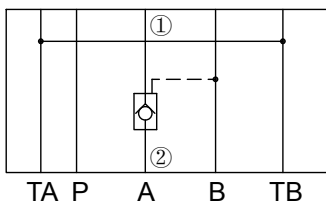

Z2S10B..3XJ/...

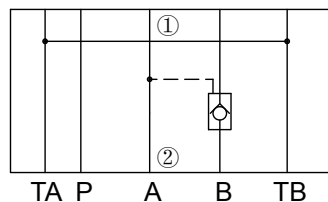

Z2S10..3XJ/...

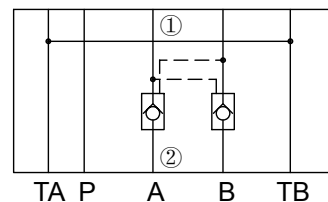

Specification

	Z2S	10		-	3XJ	/		*
Modular Hydraulic check valve	Further details in clear text							
Nominal size 10	=10							
Leak-free closure in channels A and B	= -							
Leak-free closure in channel A	= A							
Leak-free closure in channel B	= B							
	No code = NBR seals							
	V = FKM seals							
	3XJ= Series 30J to 39J (30J to 39J: unchanged installation and connection dimensions)							
	1 = Crack pressure 1.5bar							
	2 = Crack pressure 3bar							
	3 = Crack pressure 6bar							
	4 = Crack pressure 10bar							

01

Technical data

Fluid		Mineral oil suitable for NBR and FKM seal Phosphate ester for FKM seal
Degree of contamination		Maximum permissible degree of fluid contamination: Class 9. NAS 1638 or 20/18/15, ISO4406
Fluid temperature range	°C	-30 to +80 (NBR seal) -20 to +80 (FKM seal)
Viscosity range	mm ² /s	2.8 to 500
Operating pressure	bar	315
Max.flow-rate	L/min	120
Flow direction		See symbol
Crack pressure(free flow direction)	bar	1.5, 3, 6, 10
Area ratio		A1/A2=1/13.4 A3/A2=1/2.68 (Please refer to page "02/04" for section drawing)
Weight	kg	3

Characteristic curves (Measured at t=40°C ±5°C , using HLP46)

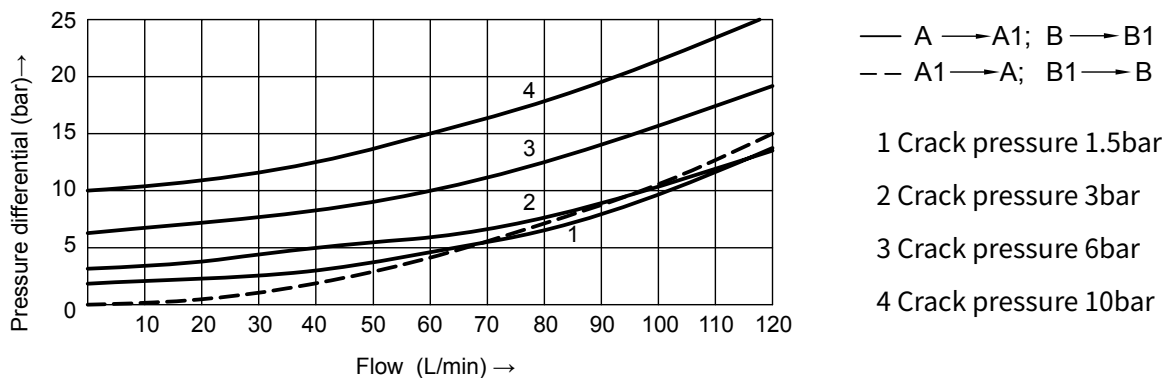

Unit dimensions

(Dimensions in mm)

01

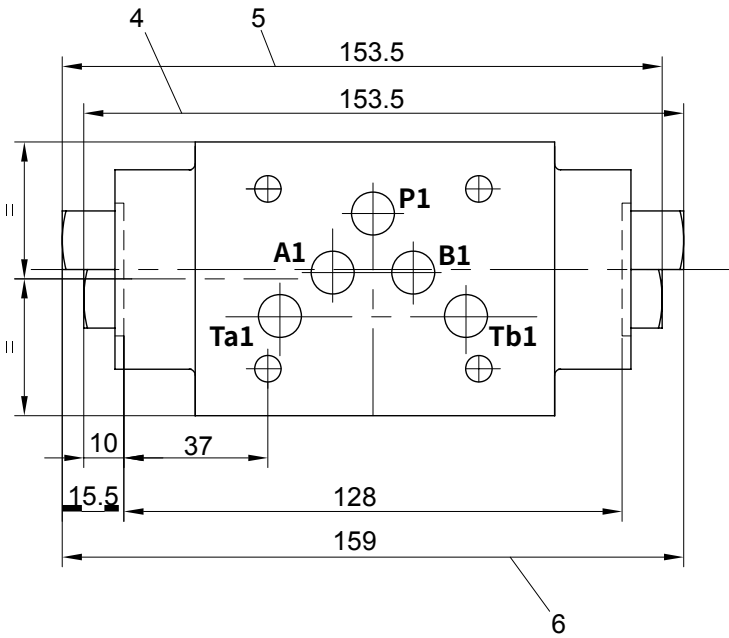
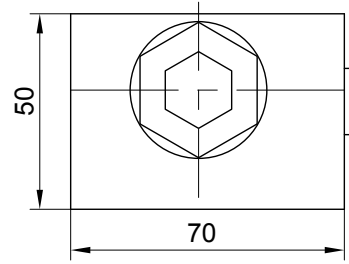
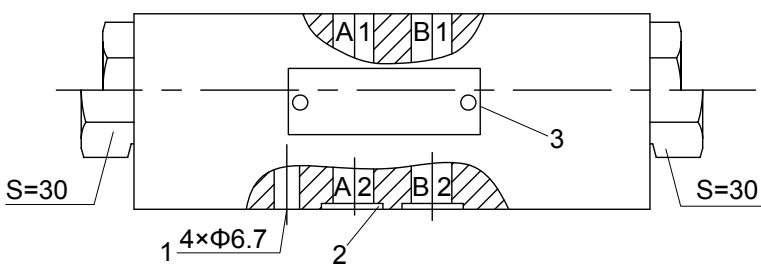

- 1 4 through holes for valve mounting screws
- 2 O-rings 12×2 for ports A, B, P, T
- 3 Name plate
- 4 Check valve in port B
- 5 Check valve in port A
- 6 Check valve in both port A and B

